



**waiting
area**



Family lounge
Meeting room
Toilets



Staff Offices

sibond



Family lounge

Meeting room

Toilets



Recepcja

Reception



Pokoje

Basen

Restauracja

Bar

Guest rooms

Pool

Restaurant

Bar

sibond



3
[2]
1
G

Green roof
BBQ area
Bar

Meeting rooms 21 - 26
Offices 200 - 225
Digital room
Rest room

Meeting rooms 11 - 15
Breakout Space
Offices 101 - 112
Kitchen
Terrace
Toilets

Reception
Exhibition space
Meetings rooms 01 - 03
Offices 001 - 022
Workshops
Bike storage
Exit



sibond

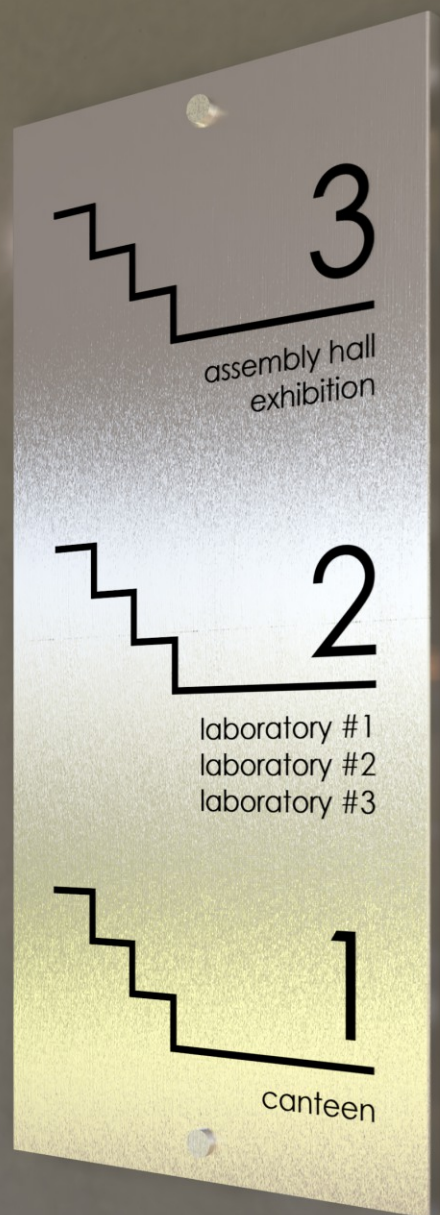

←
book browse
adult fiction
adult non-fiction
journals
newspapers

↖
book browse
adult fiction
adult non-fiction
journals
newspapers

←
large size books
researchers' centre
group study rooms
silent study rooms
→
reception
caffe
exit

sibond

1111

2







Guestrooms

206 - 233



Guestrooms

23

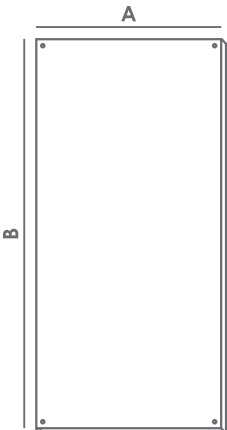
Rysunek techniczny Technical drawing Technische Zeichnung	Numer artykułu Article number Artikelnummer	Wymiar Size Größe (mm)		Nazwa produktu Product name Produktname
		A	B	
	K-SIBD2-XX-001	120	300	Tablica przestrzenna z 2 otworami 3D plate with 2 holes Dreidimensionale Tafel mit 2 Löchern
	K-SIBD2-XX-002	120	600	
	K-SIBD2-XX-003	270	600	Tablica przestrzenna z 4 otworami 3D plate with 4 holes Dreidimensionale Tafel mit 4 Löchern
	K-SIBD2-XX-004	270	1200	
	K-SIBD2-XX-005	570	1200	

sibond



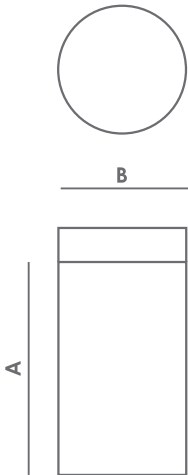



Rysunek techniczny Technical drawing Technische Zeichnung	Numer artykułu Article number Artikelnummer	Wymiar Size Größe (mm)		Nazwa produktu Product name Produktname
		A	B	
	A-DST25-01-000	25	15	Dystans aluminiowy - srebrna anoda, powierzchnia szczotkowana Aluminum standoff - silver anodized, brushed surface Aluminium-Distanzstück - silberne Anode, gebürstete Oberfläche

sibond

0

7

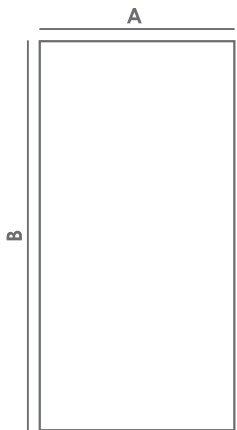
Rysunek techniczny Technical drawing Technische Zeichnung	Numer artykułu Article number Artikelnummer	Wymiar Size Größe (mm)		Nazwa produktu Product name Produktname
		A	B	
	K-SIBD1-XX-001	150	300	Tablica płaska bez otworów Flat plate without holes Flache Tafel ohne Löcher
	K-SIBD1-XX-002	150	600	
	K-SIBD1-XX-003	300	600	
	K-SIBD1-XX-004	300	1200	
	K-SIBD1-XX-005	600	1200	

sibond



hello!

ask

us

tourist

information

System informacji wizualnej wykonany z nowoczesnych materiałów kompozytowych. Specjalna konstrukcja jest wytrzymała na wpływ zmian temperatury i wilgotności powietrza. Kolekcja zawiera dwie wersje wykonania - tablice informacyjne płaskie, montowane bezpośrednio do ściany za pomocą kleju montażowego, oraz tablice przestrzenne, montowane za pomocą dystansów. Srebrna powierzchnia z wykończeniem szczotkowanym otwiera przestrzeń do realizacji kreatywnych projektów i tworzy wyjątkową strefę informacyjną budynku.

Visual information system made of modern composite materials. The special construction is resistant to temperature and humidity variations. The collection includes two versions - flat information plates, mounted directly to the wall with mounting adhesive, and 3D plates, mounted on standoffs. The silver surface with a brushed finish opens up space for creative designs and creates a unique information area for the building.

Das System der visuellen Information ist aus modernen Verbundstoffen gefertigt. Der spezielle Aufbau ist gegen Auswirkungen der Temperatur- und Luftfeuchtigkeitsschwankungen beständig. In der Kollektion sind zwei Ausführungen erhältlich - flache Anzeigetafeln, die mit Montagekleber unmittelbar an die Wand montiert werden, sowie dreidimensionale Tafeln, die mit Distanzstücken montiert werden. Die silberne Oberfläche mit gebürsteter Behandlung öffnet den Raum zur Umsetzung von kreativen Projekten und gestaltet eine besondere Informationszone des Gebäudes.

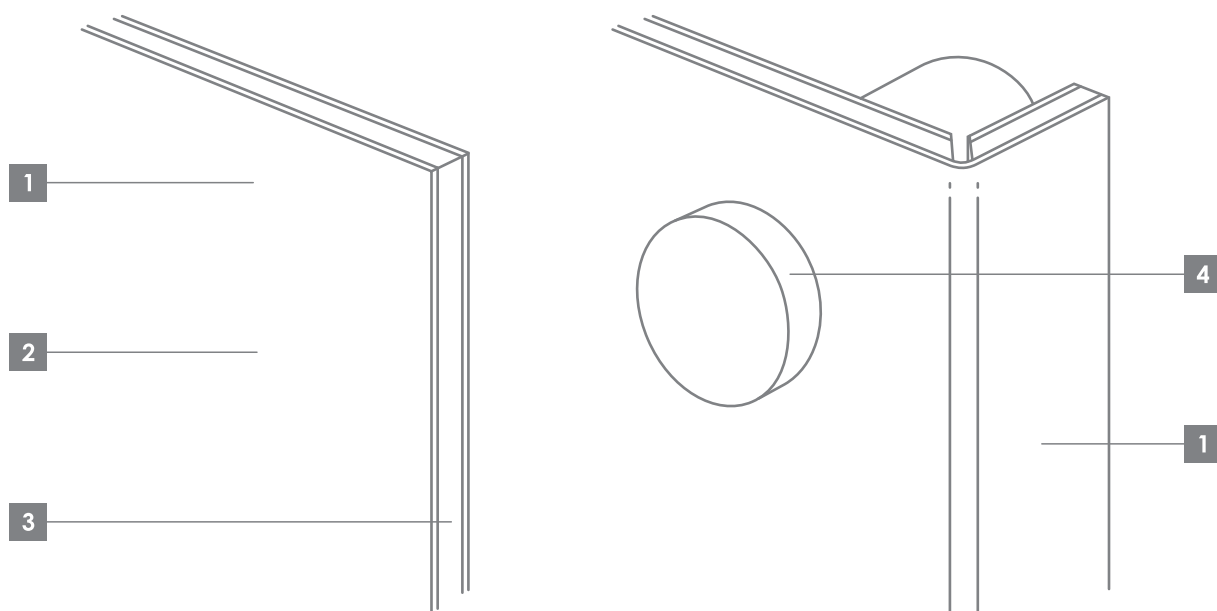

1 Tablica informacyjna - wersja płaska i przestrzenna, grubość materiału: 2 mm

Information plate - flat and 3D version, material thickness: 2 mm

Anzeigetafel - flache und dreidimensionale Version, Materialdicke: 2 mm

2 Powierzchnia aluminiowa srebrna, z wykończeniem szczotkowanym

Silver aluminum surface with brushed finish

Silberne Aluminium-Oberfläche, mit gebürsteter Behandlung

3 Rdzeń polietylenowy

Polyethylene core

Polyethylenkern

4 Dystans aluminiowy

Aluminum standoff

Aluminium-Distanzstück